

OPTOTRONIC Intelligent – DALI NFC I

Compact constant current LED driver – Dimmable



Areas of application

- Suitable for downlights, spotlights and LED panels
- Suitable for use in luminaires with flexible current setting
- Installation in emergency lighting systems according to IEC 61347-2-13, appendix J
- Suitable for indoor SELV installations
- Suitable for luminaires of protection classes I and II

Product family benefits

- Versatile DALI window driver due to flexible output characteristic
- Locking and unlocking of luminaire/driver data
- Easy and fast output current setting via NFC
- Very high efficiency
- High-quality dimming of 1...100 % by amplitude dimming
- DALI-2 certified incl. Parts 251, 252, 253



Product family datasheet

Product family features

- Supply voltage: 220...240 V
- Line frequency: 0 Hz, 50...60 Hz
- Line voltage: 198...264 V
- According to EN 61347-1, 61347-2-13, 62384
- RI suppression: to EN 55015/CISPR 15
- Immunity according to EN 61547
- Type of protection: IP20
- Integrated cable clamp for luminaire and independent installation

Product family datasheet

Technical data

Electrical data

Product description	Nominal input voltage	Mains frequency	Input voltage AC	Input voltage DC	Total harmonic distortion	Power factor λ
OTi DALI 10/220...240/700 NFC I	220...240 V	0/50/60 Hz	198...264 V ¹⁾	176...276 V	15 % ²⁾	> 0.98/> 0.94 ³⁾
OTi DALI 20/220...240/500 NFC I	220...240 V	0,50,60 Hz	198...264 V ¹⁾	176...276 V	< 10 % ²⁾	\geq 0.95
OTi DALI 30/220...240/700 NFC I	220...240 V	0,50,60 Hz	198...264 V ¹⁾	176...276 V	< 10 % ²⁾	\geq 0.95
OTi DALI 40/220...240/1A0 NFC I	220...240 V	0,50,60 Hz	198...264 V ¹⁾	176...276 V	< 10 % ²⁾	\geq 0.95

Product description	Efficiency in full-load	Device power loss	Networked standby power	Inrush current
OTi DALI 10/220...240/700 NFC I	82 % ⁴⁾	3,5 W	\leq 0.15 W ⁴⁾	< 5 A ⁵⁾
OTi DALI 20/220...240/500 NFC I	88 % ⁴⁾		\leq 0.18 W ⁴⁾	< 20 A ¹⁰⁾
OTi DALI 30/220...240/700 NFC I	90 % ⁴⁾		\leq 0.18 W ⁴⁾	< 20 A ¹⁰⁾
OTi DALI 40/220...240/1A0 NFC I	91 % ⁴⁾		\leq 0.18 W ⁴⁾	< 20 A ¹⁰⁾

Product description	Max. ECG no. on circuit breaker 10 A (B)	Max. ECG no. on circuit breaker 16 A (B)	Surge capability (L/N-Ground)	Surge capability (L-N)
OTi DALI 10/220...240/700 NFC I	80	130	2 kV	1 kV
OTi DALI 20/220...240/500 NFC I	20	30	2 kV	1 kV
OTi DALI 30/220...240/700 NFC I	20	30	2 kV	1 kV
OTi DALI 40/220...240/1A0 NFC I	20	30	2 kV	1 kV

Product description	Nominal output voltage	U-OUT (working voltage)	Nominal output current	Default output current	Output current tolerance
OTi DALI 10/220...240/700 NFC I	2.5...45 V ⁶⁾	60 V	150...700 mA ⁷⁾	350 mA	\pm 3 %
OTi DALI 20/220...240/500 NFC I	20...50 V ⁶⁾	60 V	200...500 mA ¹¹⁾	350 mA	\pm 5 %
OTi DALI 30/220...240/700 NFC I	20...50 V ⁶⁾	60 V	350...700 mA ¹¹⁾	500 mA	\pm 5 %
OTi DALI 40/220...240/1A0 NFC I	20...50 V ⁶⁾	60 V	500...1050 mA ¹¹⁾	700 mA	\pm 5 %

Product description	Output ripple current (100 Hz)	Output PSTLM	Output SVM	Nominal output power
OTi DALI 10/220...240/700 NFC I	< 2 % ⁸⁾	\leq 1	\leq 0.4	10 W ⁹⁾
OTi DALI 20/220...240/500 NFC I	< 5 % ¹²⁾	\leq 1	\leq 0.4	20 W ¹³⁾
OTi DALI 30/220...240/700 NFC I	< 5 % ¹²⁾	\leq 1	\leq 0.4	30 W ¹⁴⁾
OTi DALI 40/220...240/1A0 NFC I	< 5 % ¹²⁾	\leq 1	\leq 0.4	40 W ¹⁵⁾

Product description	Maximum output power	Galvanic isolation DALI/output	Current set
OTi DALI 10/220...240/700 NFC I	10 W	SELV	DALI / NFC
OTi DALI 20/220...240/500 NFC I	20 W	SELV	DALI / NFC

Product family datasheet

Product description	Maximum output power	Galvanic isolation DALI/output	Current set
OTi DALI 30/220...240/700 NFC I	30 W	SELV	DALI / NFC
OTi DALI 40/220...240/1A0 NFC I	40 W	SELV	DALI / NFC

Product description	Galvanic isolation primary/secondary	Galvanic isolation DALI/mains
OTi DALI 10/220...240/700 NFC I	SELV	Basic
OTi DALI 20/220...240/500 NFC I	SELV	Basic
OTi DALI 30/220...240/700 NFC I	SELV	Basic
OTi DALI 40/220...240/1A0 NFC I	SELV	Basic

1) Permitted voltage range

2) At full load, 220...240 V, 50 Hz / see graphs

3) At Pmax, 220...240 V, 50 Hz/At 50% Pmax, 220...240 V, 50 Hz

4) at 230 V, 50 Hz

5) $t_{width} = 100 \mu s$ (measured at 50 % I_{peak})

6) Maximum 60 V

7) ±3%

8) Ripple / average @ 100 Hz

9) Partial load 1.5...10 W

10) $t_{width} = 200 \mu s$ (measured at 50 % I_{peak})

11) ±5%

12) Ripple average at 100 Hz

13) Partial load 4...20 W

14) Partial load 10...30 W

15) Partial load 20...40 W

Dimensions & weight

Product description	Mounting hole spacing, length	Product weight	Cable cross-section, input side	Cable cross-section, output side	Wire preparation length, input side
OTi DALI 10/220...240/700 NFC I	132.0 mm	76.00 g	0.2...1.5 mm ² ¹⁾	0.2...1.5 mm ² ¹⁾	8.0...9.1 mm
OTi DALI 20/220...240/500 NFC I	186.5 mm	160.00 g	0.2...2.5 mm ² ¹⁾	0.2...1.5 mm ² ¹⁾	7...8 mm
OTi DALI 30/220...240/700 NFC I	186.5 mm	160.00 g	0.2...2.5 mm ² ¹⁾	0.2...1.5 mm ² ¹⁾	7...8 mm
OTi DALI 40/220...240/1A0 NFC I	186.5 mm	170.00 g	0.2...2.5 mm ² ¹⁾	0.2...1.5 mm ² ¹⁾	7...8 mm

Product description	Wire preparation length, output side	Length	Width	Height
OTi DALI 10/220...240/700 NFC I	8.0...9.1 mm	166.0 mm	30.0 mm	22.0 mm
OTi DALI 20/220...240/500 NFC I	8.0...9.0 mm	204.0 mm	50.0 mm	32.0 mm
OTi DALI 30/220...240/700 NFC I	8.0...9.0 mm	204.0 mm	50.0 mm	32.0 mm
OTi DALI 40/220...240/1A0 NFC I	8.0...9.0 mm	204.0 mm	50.0 mm	32.0 mm

1) Solid or flexible leads

Product family datasheet

Product line drawing

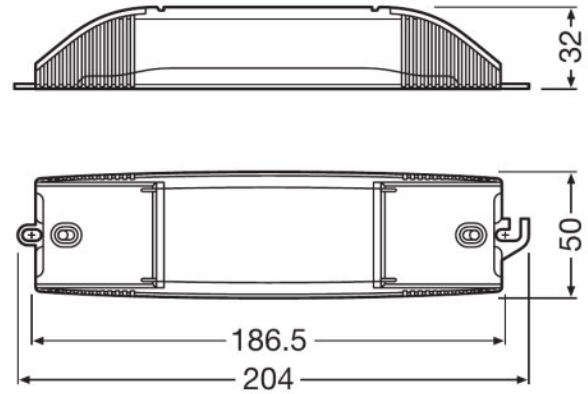
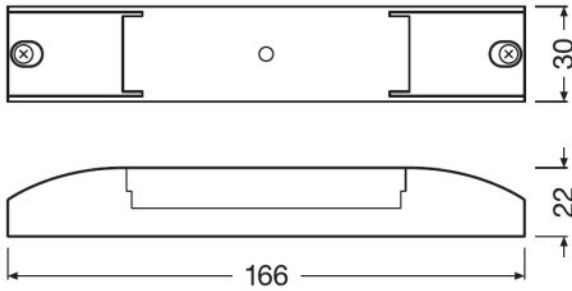

OTi DALI 10/220...240/700 NFC I

OTi DALI 20/220...240/500 NFC I, OTi DALI 30/220...240/700 NFC I, OTi DALI 40/220...240/1A0 NFC I

Colors & materials

Product description	Casing material
OTi DALI 10/220...240/700 NFC I	Plastic
OTi DALI 20/220...240/500 NFC I	Plastic
OTi DALI 30/220...240/700 NFC I	Plastic
OTi DALI 40/220...240/1A0 NFC I	Plastic

Temperatures & operating conditions

Product description	Ambient temperature range	Maximum temperature at tc test point	Max.housing temperature in case of fault	Temperature range at storage
OTi DALI 10/220...240/700 NFC I	-25...+50 °C	75 °C ¹⁾	110 °C	-40...+85 °C
OTi DALI 20/220...240/500 NFC I	-20...+50 °C	75 °C ¹⁾	110 °C	-25...85 °C
OTi DALI 30/220...240/700 NFC I	-20...+50 °C	80 °C ¹⁾	110 °C	-25...85 °C
OTi DALI 40/220...240/1A0 NFC I	-20...+50 °C	85 °C ¹⁾	110 °C	-25...85 °C

Product description	Permitted rel. humidity during operation
OTi DALI 10/220...240/700 NFC I	5...85 % ²⁾
OTi DALI 20/220...240/500 NFC I	5...85 % ²⁾

Product family datasheet

Product description	Permitted rel. humidity during operation
OTi DALI 30/220...240/700 NFC I	5...85 % ²⁾
OTi DALI 40/220...240/1A0 NFC I	5...85 % ²⁾

¹⁾ Maximum at the T_c-point

²⁾ Maximum 56 days/year at 85 %

Lifespan

Product description	ECG lifetime
OTi DALI 10/220...240/700 NFC I	50000 / 100000 h ¹⁾
OTi DALI 20/220...240/500 NFC I	50000 / 100000 h ¹⁾
OTi DALI 30/220...240/700 NFC I	50000 / 100000 h ²⁾
OTi DALI 40/220...240/1A0 NFC I	50000 / 100000 h ³⁾

¹⁾ T_c = 75°C, 0.2% / 1,000 h failure rate / T_c = 65°C, 0.1% / 1,000 h failure rate

²⁾ T_c = 80°C, 0.2% / 1,000 h failure rate / T_c = 70°C, 0.1% / 1,000 h failure rate

³⁾ T_c = 85°C, 0.2% / 1,000 h failure rate / T_c = 75°C, 0.1% / 1,000 h failure rate

Additional product data

Product description	Encapsulated
OTi DALI 10/220...240/700 NFC I	No
OTi DALI 20/220...240/500 NFC I	No
OTi DALI 30/220...240/700 NFC I	No
OTi DALI 40/220...240/1A0 NFC I	No

Capabilities

Product description	Dimmable	Dimming interface	Dimming range	Dimming method
OTi DALI 10/220...240/700 NFC I	Yes	DALI-2 / Touch DIM / Touch DIM Sensor	1...100 % ¹⁾	Amplitude Modulation
OTi DALI 20/220...240/500 NFC I	Yes	DALI-2	1...100 % ¹⁾	Amplitude Modulation
OTi DALI 30/220...240/700 NFC I	Yes	DALI-2	1...100 % ¹⁾	Amplitude Modulation
OTi DALI 40/220...240/1A0 NFC I	Yes	DALI-2	1...100 % ¹⁾	Amplitude Modulation

Product description	Overheating protection	Overload protection	Short-circuit protection	No-load proof
OTi DALI 10/220...240/700 NFC I	Automatic reversible	Automatic reversible	Automatic reversible	Yes
OTi DALI 20/220...240/500 NFC I	Automatic reversible	Automatic reversible	Automatic reversible	Yes
OTi DALI 30/220...240/700 NFC I	Automatic reversible	Automatic reversible	Automatic reversible	Yes
OTi DALI 40/220...240/1A0 NFC I	Automatic reversible	Automatic reversible	Automatic reversible	Yes

Product description	Intended for no-load operation	Max. cable length to lamp/LED module	Suitable for fixtures with prot. class	Type of connection, input side
OTi DALI 10/220...240/700 NFC I	No	2.0 m	I / II	Push terminal

Product family datasheet

Product description	Intended for no-load operation	Max. cable length to lamp/LED module	Suitable for fixtures with prot. class	Type of connection, input side
OTi DALI 20/220...240/500 NFC I	No	2.0 m	I / II	Screw terminal
OTi DALI 30/220...240/700 NFC I	No	2.0 m	I / II	Screw terminal
OTi DALI 40/220...240/1A0 NFC I	No	2.0 m	I / II	Screw terminal

Product description	Type of connection, output side	Suitable for emergency lighting	Constant lumen function	Programming interface
OTi DALI 10/220...240/700 NFC I	Push terminal	Yes	Programmable	DALI, NFC
OTi DALI 20/220...240/500 NFC I	Push terminal	Yes	Programmable	DALI, NFC
OTi DALI 30/220...240/700 NFC I	Push terminal	Yes	Programmable	DALI, NFC
OTi DALI 40/220...240/1A0 NFC I	Push terminal	Yes	Programmable	DALI, NFC

Product description	DALI-2 Energy Data	DALI-2 Diagnostic Data	Control interface
OTi DALI 10/220...240/700 NFC I	Yes ²⁾	Yes ³⁾	DALI
OTi DALI 20/220...240/500 NFC I	Yes ²⁾	Yes ³⁾	DALI
OTi DALI 30/220...240/700 NFC I	Yes ²⁾	Yes ³⁾	DALI
OTi DALI 40/220...240/1A0 NFC I	Yes ²⁾	Yes ³⁾	DALI

Product description	Number of channels
OTi DALI 10/220...240/700 NFC I	1
OTi DALI 20/220...240/500 NFC I	1
OTi DALI 30/220...240/700 NFC I	1
OTi DALI 40/220...240/1A0 NFC I	1

¹⁾ For maximum nominal output current

²⁾ Acc. DALI part 252

³⁾ Acc. DALI part 253

Programming

Product description	Programming device	Tuner4TRONIC Field App	Tuner4TRONIC
OTi DALI 10/220...240/700 NFC I	DALI / NFC	Yes	Yes
OTi DALI 20/220...240/500 NFC I	DALI / NFC	Yes	Yes
OTi DALI 30/220...240/700 NFC I	DALI / NFC	Yes	Yes
OTi DALI 40/220...240/1A0 NFC I	DALI / NFC	Yes	Yes

Product description	Box programming
OTi DALI 10/220...240/700 NFC I	Yes
OTi DALI 20/220...240/500 NFC I	Yes
OTi DALI 30/220...240/700 NFC I	Yes
OTi DALI 40/220...240/1A0 NFC I	Yes

Product family datasheet

Programmable features

Product description	OEM Key	Configuration Lock	DALI-2 Luminaire Data
OTi DALI 10/220...240/700 NFC I	No	Yes	Yes ¹⁾
OTi DALI 20/220...240/500 NFC I	No	Yes	Yes ¹⁾
OTi DALI 30/220...240/700 NFC I	No	Yes	Yes ¹⁾
OTi DALI 40/220...240/1A0 NFC I	No	Yes	Yes ¹⁾

Product description	Emergency Mode	Dim to Dark	Soft Switch Off
OTi DALI 10/220...240/700 NFC I	Yes	Yes	Yes
OTi DALI 20/220...240/500 NFC I	Yes	Yes	Yes
OTi DALI 30/220...240/700 NFC I	Yes	Yes	Yes
OTi DALI 40/220...240/1A0 NFC I	Yes	Yes	Yes

Product description	Driver Guard	DALI Settings	Constant Lumen
OTi DALI 10/220...240/700 NFC I	Yes	Yes	Yes
OTi DALI 20/220...240/500 NFC I	Yes	Yes	Yes
OTi DALI 30/220...240/700 NFC I	Yes	Yes	Yes
OTi DALI 40/220...240/1A0 NFC I	Yes	Yes	Yes

Product description	Lamp Operating Time
OTi DALI 10/220...240/700 NFC I	Yes
OTi DALI 20/220...240/500 NFC I	Yes
OTi DALI 30/220...240/700 NFC I	Yes
OTi DALI 40/220...240/1A0 NFC I	Yes

¹⁾ Acc. DALI part 251

Product family datasheet

Certificates & standards

Product description	Approval marks – approval	Standards	Protection class	Type of protection
OTi DALI 10/220...240/700 NFC I	ENEC / VDE-EMC / EL / CE / DALI-2	Acc. to IEC 61347-1/Acc. to IEC 61347-2-13/Acc. to IEC 55015/Acc. to IEC 61547/Acc. to IEC 61000-3-2/Acc. to IEC 62384/Acc. to IEC 62386/Acc. to IEC 62386-101:Ed2/Acc. to IEC 62386-102:Ed2/Acc. to IEC 62386-207:Ed1	II	IP20
OTi DALI 20/220...240/500 NFC I	CE / EL / DALI-2 / EAC	Acc. to EN 61347-1/Acc. to EN 61347-2-13/Acc. to EN 55015/Acc. to EN 61547/Acc. to EN 61000-3-2/Acc. to EN 62384/Acc. to EN 62386/Acc. to IEC 62386-101:Ed2/Acc. to IEC 62386-102:Ed2/Acc. to IEC 62386-207:Ed1	II	IP20
OTi DALI 30/220...240/700 NFC I	CE / UKCA / EL / DALI-2 / EAC	Acc. to EN 61347-1/Acc. to EN 61347-2-13/Acc. to EN 55015/Acc. to EN 61547/Acc. to EN 61000-3-2/Acc. to EN 62384/Acc. to EN 62386/Acc. to IEC 62386-101:Ed2/Acc. to IEC 62386-102:Ed2/Acc. to IEC 62386-207:Ed1	II	IP20
OTi DALI 40/220...240/1A0 NFC I	CE / UKCA / EL / DALI-2 / EAC	Acc. to EN 61347-1/Acc. to EN 61347-2-13/Acc. to EN 55015/Acc. to EN 61547/Acc. to EN 61000-3-2/Acc. to EN 62384/Acc. to EN 62386/Acc. to IEC 62386-101:Ed2/Acc. to IEC 62386-102:Ed2/Acc. to IEC 62386-207:Ed1	II	IP20

Logistical data

Product description	Commodity code
OTi DALI 10/220...240/700 NFC I	850440829000
OTi DALI 20/220...240/500 NFC I	850440829000
OTi DALI 30/220...240/700 NFC I	850440829000
OTi DALI 40/220...240/1A0 NFC I	850440829000

Product family datasheet

Environmental information

Product description	Date of Declaration	Primary Article Identifier	Candidate List Substance 1
OTi DALI 10/220...240/700 NFC I	23-12-2021	4062172151252	Lead
OTi DALI 20/220...240/500 NFC I	23-12-2021	4062172114967	Lead
OTi DALI 30/220...240/700 NFC I	23-12-2021	4062172114981	Lead
OTi DALI 40/220...240/1A0 NFC I	23-12-2021	4062172115001	Lead

Product description	CAS No. of substance 1	Safe Use Instruction	Declaration No. in SCIP database
OTi DALI 10/220...240/700 NFC I	7439-92-1	The identification of the Candidate List substance is sufficient to allow safe use of the article.	29b9dba8-1ed1-4837-96a0-fbcd3972c828
OTi DALI 20/220...240/500 NFC I	7439-92-1	The identification of the Candidate List substance is sufficient to allow safe use of the article.	fd8ca83a-75a8-49e2-989f-9ebc23d8424c
OTi DALI 30/220...240/700 NFC I	7439-92-1	The identification of the Candidate List substance is sufficient to allow safe use of the article.	1c69644f-51ce-4cb9-a414-503d5ea94559
OTi DALI 40/220...240/1A0 NFC I	7439-92-1	The identification of the Candidate List substance is sufficient to allow safe use of the article.	118d3f95-fd93-438e-839c-3e569b720fd1



Application advice

For more detailed application information and graphics please see product datasheet.















Sales and Technical Support

Sales and Technical Support www.osram.com

Download Data

File
 User instruction OPTOTRONIC LED Power Supply
 Certificates OTI DALI 10 NFC I EATON 091220
 Certificates OTI DALI 10 NFC I INOTEC 091220

Product family datasheet

	Certificates OTI DALI NFC I CCC 2020171002003881 280121
	Certificates OT ENEC 40038447 161221
	Certificates OT EMC 40044675 250621
	Declarations of conformity OTI DALI NFC S I CE 4169161 210921
	Declarations of conformity OTI DALI NFC S I UK DoC 4281113 210921
	CAD data OTI DALI 10 NFC I IGS 031220
	CAD data OTI DALI 10 NFC I STEP 031220
	CAD Data 2-dim OTI DALI 10 NFC I CAD2PDF 031220
	CAD data 3-dim OTI DALI 10 NFC I CAD3PDF 031220
	User instruction OPTOTRONIC LED Power Supply
	CAD data 3-dim PTi 20 I CAD3PDF
	CAD data 3-dim PTi 20 I IGS
	CAD data 3-dim PTi 20 I STEP
	CAD data PDF PTi 20 I CAD2PDF

Ecodesign regulation information:

Intended for use with LED modules.

The forward voltage of the LED light source shall be within the defined operating window of the control gear in all operating conditions including dimming if applicable.

Separate control gear and light sources must be disposed of at certified disposal companies in accordance with Directive 2012/19/EU (WEEE) in the EU and with Waste Electrical and Electronic Equipment (WEEE) Regulations 2013 in the UK. For this purpose, collection points for recycling centres and take-back systems (CRSO) are available from retailers or private disposal companies, which accept separate control gear and light sources free of charge. In this way, raw materials are conserved and materials are recycled.

Product family datasheet

Logistical Data

Product code	Product description	Packaging unit (Pieces/Unit)	Dimensions (length x width x height)	Volume	Gross weight
4062172151252	OTi DALI 10/220...240/700 NFC I	Shipping carton box 20	344 mm x 126 mm x 83 mm	3.60 dm ³	1639.00 g
4062172114967	OTi DALI 20/220...240/500 NFC I	Shipping carton box 20	428 mm x 173 mm x 121 mm	8.96 dm ³	3467.00 g
4062172114981	OTi DALI 30/220...240/700 NFC I	Shipping carton box 20	428 mm x 173 mm x 121 mm	8.96 dm ³	3467.00 g
4062172115001	OTi DALI 40/220...240/1A0 NFC I	Shipping carton box 20	428 mm x 173 mm x 121 mm	8.96 dm ³	3667.00 g

The mentioned product code describes the smallest quantity unit which can be ordered. One shipping unit can contain one or more single products. When placing an order, for the quantity please enter single or multiples of a shipping unit.

Data privacy

This OSRAM driver can be configured using the Tuner4TRONIC software. This requires registering on www.myosram.com and downloading the Tuner4TRONIC software from the Internet. The Tuner4TRONIC software enables users to access and view the operational data of a luminaire or driver via the corresponding programming interfaces. A password key (Config Lock) must be set up in the driver via the Tuner4TRONIC software in order to control which users can access and view operational data. Follow the instructions for password setup. To grant an external person or company rights to access or view operational data, you can assign password keys. In this case, however, you are responsible for ensuring that the third party concerned takes notice of the information described here. However, OSRAM can read out operating data from devices for maintenance and service purposes even when a password key has been assigned. In individual cases, OSRAM will also use its access rights in order to optimize or improve driver hardware and driver functions. In accordance with data privacy principles, any user of operating data (luminaire manufacturers, third parties with access rights) must ensure that personal data (e.g. name, address, location IDs) are only merged with the prior written consent of the person (end user) concerned. The respective user of the operating data is responsible for providing evidence of consent.

Disclaimer

Subject to change without notice. Errors and omission excepted. Always make sure to use the most recent release.